

SAMSUNG

ELECTRONICS

Product Information



Product Information

SAMSUNG TFT-LCD

MODEL NO. : LTN154U2-L04-0

LCD Product Planning Group 1, Marketing Team

Samsung Electronics Co . , LTD.



CONTENTS

General Description	----- (3)
1. Electrical Absolute Ratings	----- (4)
2. Optical Characteristics	----- (5)
3. Electrical Characteristics	----- (6)
3.1 TFT LCD Module	
3.2 Backlight Unit	
4. Block Diagram	----- (7)
4.1 TFT LCD Module	
4.2 Backlight Unit	
5. Input Terminal Pin Assignment	----- (8)
5.1 Input Signal & Power	
5.2 Backlight Unit	
5.3 Timing Diagrams of LVDS For Transmitting	
6. Interface Timing	----- (10)
6.1 Timing Parameters	
6.2 Timing Diagrams of interface Signal	
6.3 Power ON/OFF Sequence	
7. Outline Dimension	----- (12)

GENERAL DESCRIPTION

DESCRIPTION

LTN154U2-L04 is a color active matrix TFT (Thin Film Transistor) liquid crystal display (LCD) that uses amorphous silicon TFT as a switching devices. This model is composed of a TFT LCD panel, a driver circuit and a backlight system. The resolution of a 15.4" contains

FEATURES

- Thin and light weight
- High contrast ratio, high aperture structure
- Super wide Viewing Angle
- Fast Response Time
- Wide UXGA(1920 X 1200) resolution
- Low power consumption
- DE (Data enable) only mode.
- 3.3V LVDS Interface
- On board EDID chip
- Pb-free product

APPLICATIONS

- Notebook PC
- If the usage of this product is not for PC application, but for others, please contact SEC

GENERAL INFORMATION

Item	Specification	Unit	Note
Display area	331.2(H) X 207.0(V) (15.4"diagonal)	mm	
Driver element	a-si TFT active matrix		
Display colors	262,144		
Number of pixel	1920 x 1200(16 : 10)	pixel	
Pixel arrangement	RGB vertical stripe		
Pixel pitch	0.1725(H) x 0.1725(V)	mm	
Display Mode	Normally white		
Surface treatment	Haze 25, Hard-Coating 3H		

MECHANICAL INFORMATION

Item		Min.	Typ.	Max.	Unit	Note
Module size	Horizontal (H)	343.5	344.0	344.5	mm	
	Vertical (V)	221.5	222.0	222.5	mm	
	Depth (D)	-	6.2	6.5	mm	(1)
Weight		-	545	560	g	

Note (1) Measurement condition of outline dimension

- . Equipment : Vernier Calipers
- . Push Force : 500g · f (minimum)

1. ELECTRICAL ABSOLUTE RATINGS**(1) TFT LCD MODULE**

$V_{DD} = 3.3V, V_{SS} = GND = 0V$

ITEM	SYMBOL	MIN.	MAX.	UNIT	NOTE
Power Supply Voltage	V_{DD}	$V_{DD} - 0.3$	$V_{DD} + 0.3$	V	(1)
Logic Input Voltage	V_{IN}	$V_{DD} - 0.3$	$V_{DD} + 0.3$	V	(1)

Note 1) Within $T_a = (25 \pm 2 \text{ } ^\circ\text{C})$

(2) BACK-LIGHT UNIT

$T_a = 25 \pm 2 \text{ } ^\circ\text{C}$

ITEM	SYMBOL	MIN.	MAX.	UNIT	NOTE
Lamp Current	I_L	3.0	7.0	mArms	(1)
Lamp frequency	f_L	50	80	kHz	(1)

Note 1) Permanent damage to the device may occur if maximum values are exceeded

Functional operation should be restricted to the conditions described under normal operating condition

2. OPTICAL CHARACTERISTICS

The following items are measured under stable conditions. The optical characteristics should be measured in a dark room or equivalent state.

Measuring equipment : TOPCON BM-5A

* Ta = 25 ± 2 °C, V_{DD}=3.3V, fv= 60Hz, fdCLK=81MHz, (IL= 6.5 mA)

Item		Symbol	Condition	Min.	Typ.	Max	Unit
Contrast Ratio (5 Points)		CR	$\phi = 0,$ $\theta = 0$	200	300	-	-
Response Time at Ta	Rising	T _R + T _F			25	35	msec
Average Luminance of White (5 Points)		Y _{L,AVE}		145	170	-	cd/m ²
Color Chromaticity (CIE)	Red	R _X		0.565	0.595	0.625	-
		R _Y		0.317	0.347	0.377	
	Green	G _X		0.289	0.319	0.349	
		G _Y		0.516	0.546	0.576	
	Blue	B _X		0.122	0.152	0.182	
		B _Y		0.106	0.136	0.166	
	White	W _X		0.283	0.313	0.343	
		W _Y		0.299	0.329	0.359	
Viewing Angle	Hor.	θ_L	CR ≥ 10	60	65		Degrees
		θ_H		60	65		
	Ver.	ϕ_H		45	50		
		ϕ_L		45	50		
13 Points White Variation		δ_L		-	-	2.2	-

3. ELECTRICAL CHARACTERISTICS

3.1 TFT LCD MODULE

Ta= 25 ± 2 °C

ITEM	SYMBOL	MIN	TYP	MAX	UNIT	NOTE	
Voltage of Power Supply	V _{DD}	3.0	3.3	3.6	V		
Differential Input Voltage for LVDS Receiver Threshold	High	V _{IH}	-	-	+100	mV	V _{CM} =+1.2V
	Low	V _{IL}	-100	-	-	mV	
Vsync Frequency	f _v	-	60	-	Hz		
Hsync Frequency	f _H	-	75	-	KHz		
Main Frequency	f _{DCLK}	-	81	-	MHz		
Rush Current	I _{RUSH}	-	-	1.5	A		
Current of Power Supply	White	I _{DD}	-	500	-	mA	
	Mosaic		-	550	-	mA	
	V.stripe		-	720	820	mA	

Note (1) Display data pins and timing signal pins should be connected.(GND=0V)

(2) f_v=60Hz, f_{DCLK} =81MHZ, V_{dd} = 3.3V , DC Current.

(3) Power dissipation pattern

3.2 BACK-LIGHT UNIT

The backlight system is an edge-lighting type with a single CCFT (Cold Cathode Fluorescent Tube). The characteristics of a single lamp are shown in the following table.

- INVERTER : SEM SIC 130T

Ta= 25 ± 2 °C

Item	Symbol	Min.	Typ.	Max.	Unit	Note
Lamp Current	I _L	2.0	6.0	6.5	mArms	
Lamp Voltage	V _L	-	700	-	Vrms	I _L =6.0mA
Frequency	f _L	40	60	80	KHz	
Power Consumption	P _L		4.2		W	I _L =6.0mA
Operating Life Time	Hr	10,000			Hour	
Startup Voltage	V _s	-	-	1230	Vrms	25°C
				1480	Vrms	0°C
Lamp startup time		-	-	1	sec	

4. BLOCK DIAGRAM

4.1 TFT LCD Module

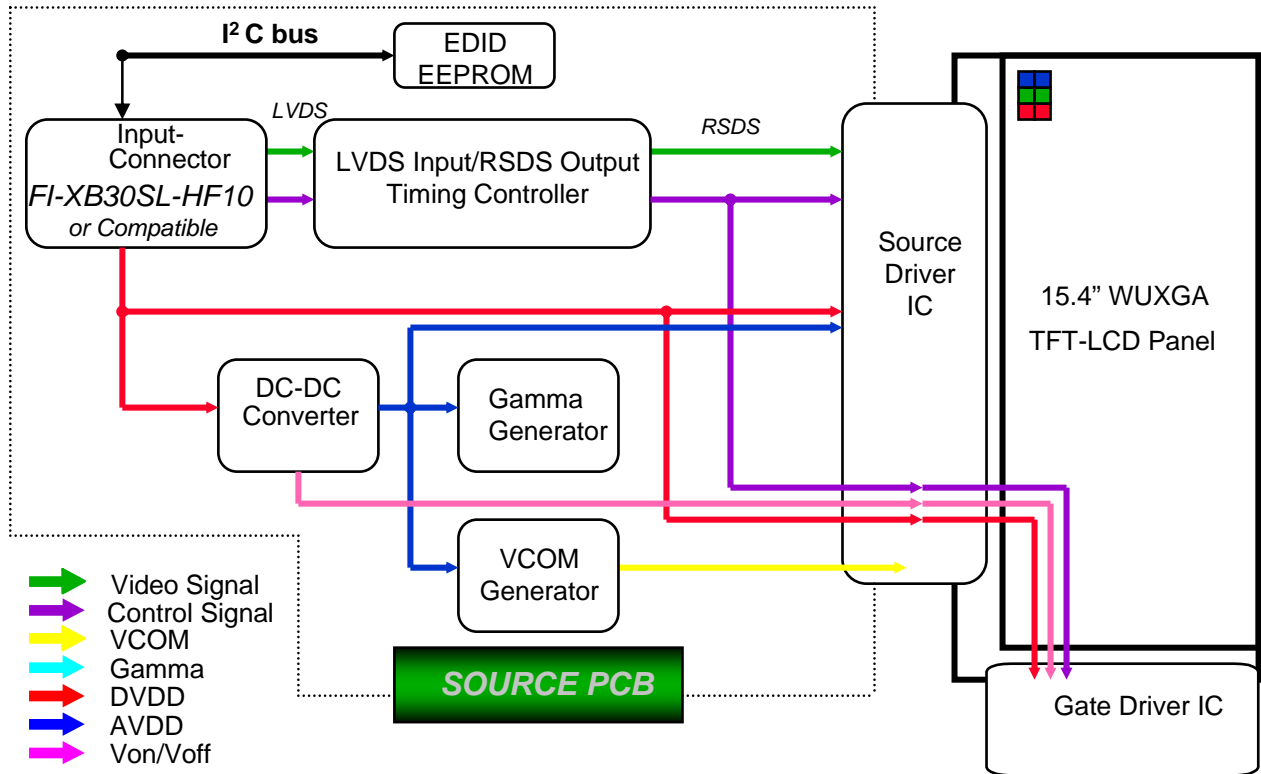

4.2 BACK-LIGHT UNIT

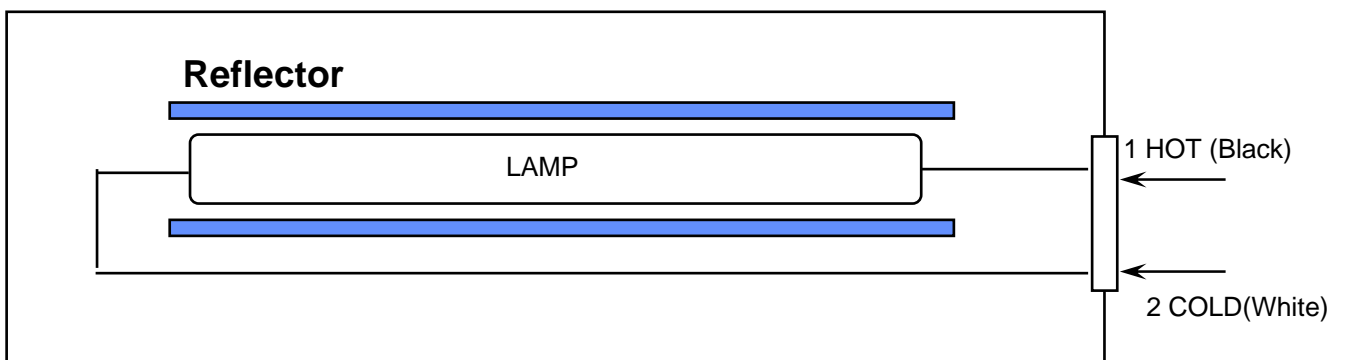

5. INPUT TERMINAL PIN ASSIGNMENT

5.1. Input Signal & Power (LVDS, Connector : JAE FI-XB30SL-HF10 or compatible)
Mating Connector : JAE FI-X30M or compatible)

No.	Symbol	Function	Polarity	Remarks
1	GND	Ground		
2	VDD	POWER SUPPLY +3.3V		
3	VDD	POWER SUPPLY +3.3V		
4	VEEDID	DDC 3.3V Power		
5	GND	Ground		
6	CLKEDID	DDC Clock		
7	DATAEDID	DDC data		
8	O_RxIN0-	LVDS Differential Data INPUT (Odd R0-R5,G0)	Negative	
9	O_RxIN0+	LVDS Differential Data INPUT (Odd R0-R5,G0)	Positive	
10	GND	Ground		
11	O_RxIN1-	LVDS Differential Data INPUT (Odd G1-G5,B0-B1)	Negative	
12	O_RxIN1+	LVDS Differential Data INPUT (Odd G1-G5,B0-B1)	Positive	
13	GND	Ground		
14	O_RxIN2-	LVDS Differential Data INPUT (Odd B2-B5,Sync,DE)	Negative	
15	O_RxIN2+	LVDS Differential Data INPUT (Odd B2-B5,Sync,DE)	Positive	
16	GND	Ground		
17	O_RxCLK-	LVDS Differential Data INPUT (Odd Clock)	Negative	
18	O_RxCLK+	LVDS Differential Data INPUT (Odd Clock)	Positive	
19	GND	Ground		
20	E_RxIN0-	LVDS Differential Data INPUT (Even R0-R5,G0)	Negative	
21	E_RxIN0+	LVDS Differential Data INPUT (Even R0-R5,G0)	Positive	
22	GND	Ground		
23	E_RxIN1-	LVDS Differential Data INPUT (Even G1-G5,B0-B1)	Negative	
24	E_RxIN1+	LVDS Differential Data INPUT (Even G1-G5,B0-B1)	Positive	
25	GND	Ground		
26	E_RxIN2-	LVDS Differential Data INPUT (Even B2-B5,Sync,DE)	Negative	
27	E_RxIN2+	LVDS Differential Data INPUT (Even B2-B5,Sync,DE)	Positive	
28	GND	Ground		
29	E_RxCLK-	LVDS Differential Data INPUT (Even Clock)	Negative	
30	E_RxCLK+	LVDS Differential Data INPUT (Even Clock)	Positive	

5.2 BACK LIGHT UNIT

Connector : JST BHSR - 02VS -1
 Mating Connector : JST SM02B-BHSS-1

Pin NO.	Symbol	Color	Function
1	HOT	Black	High Voltage
2	COLD	White	Low Voltage

5.3 Timing Diagrams of LVDS For Transmission

LVDS Receiver : Integrated T-CON

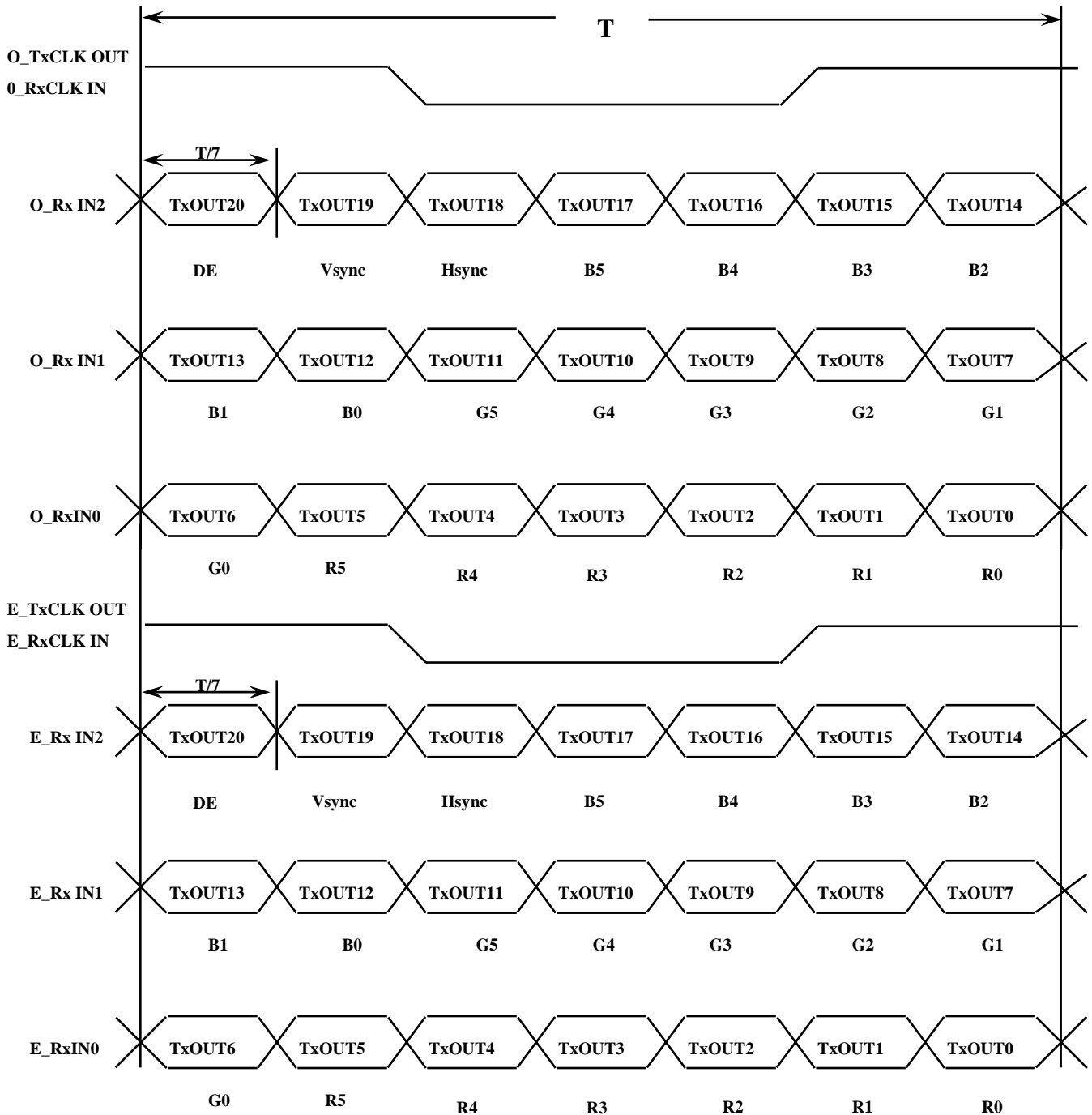

6. INTERFACE TIMING

6.1 Timing Parameters

Signal	Item	Symbol	MIN	TYP	MAX	Unit	Note
Frame Frequency	Cycle	T_v	1204	1250	1400	lines	
Vertical Active Display Term	Display Period	T_{VD}	-	1200	-	lines	
One Line Scanning Time	Cycle	T_H	1030	1080	1170	clocks	
Horizontal Active Display Term	Display Period	T_{HD}	-	960	-	clocks	

6.2 Timing diagrams of interface signal

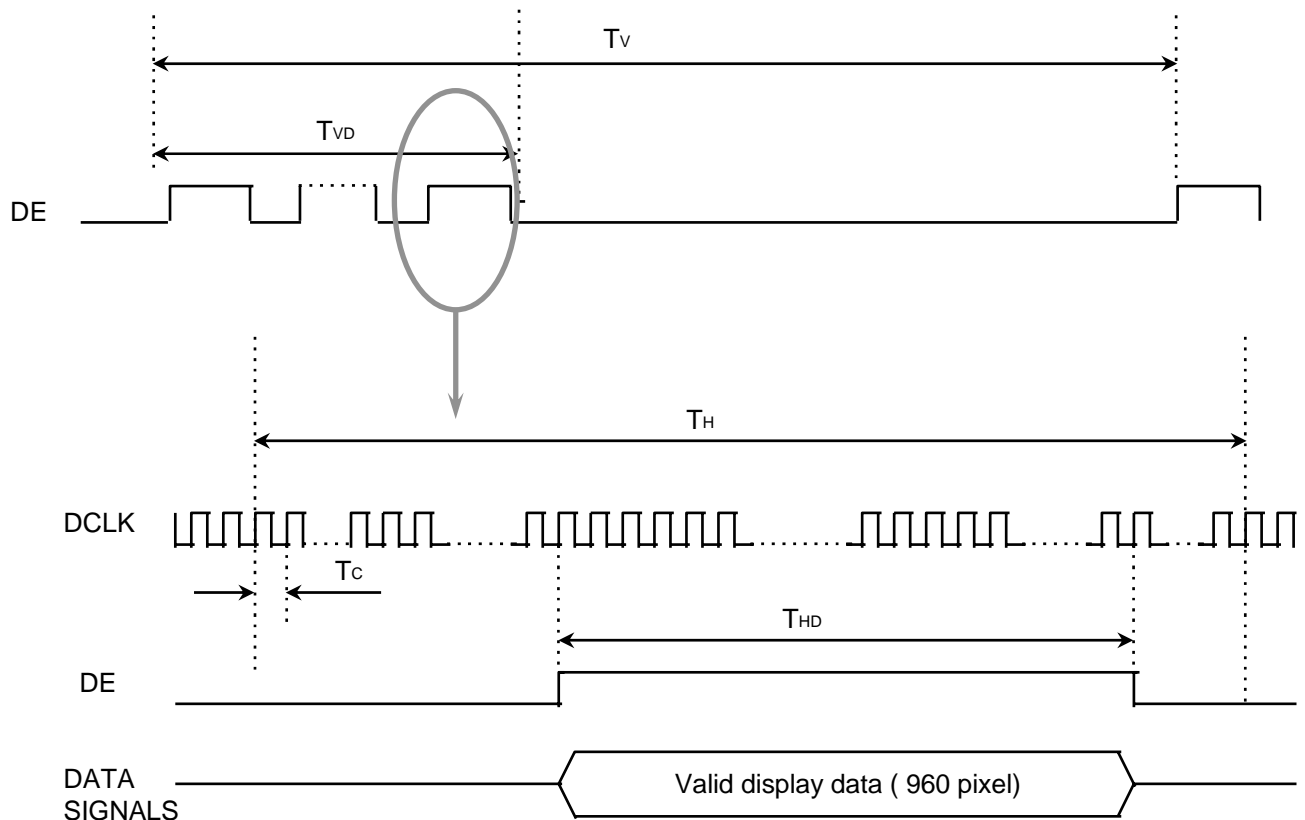

6.3 Power ON/OFF Sequence

: To prevent a latch-up or DC operation of the LCD module, the power on/off sequence should be as the diagram below.

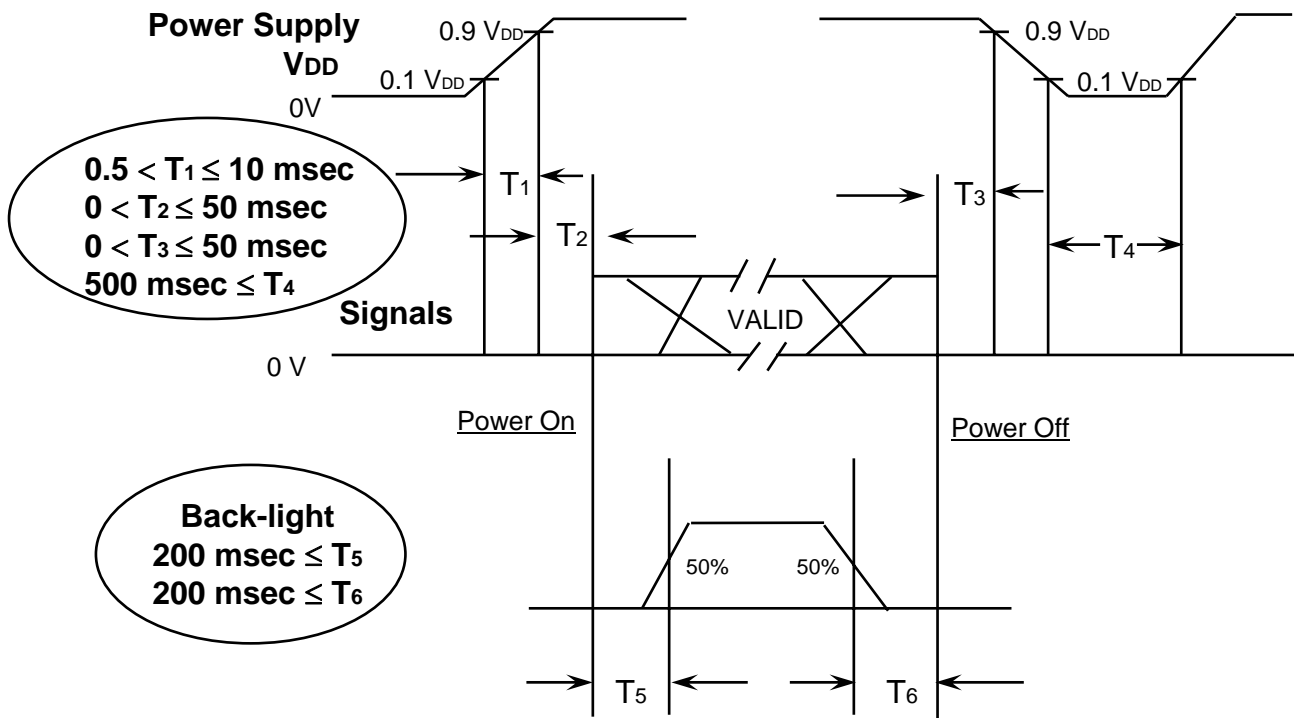

Power ON/OFF Sequence

- T1 : Vdd rising time from 10% to 90%
- T2 : The time from Vdd to valid data at power ON.
- T3 : The time from valid data off to Vdd off at power Off.
- T4 : Vdd off time for Windows restart
- T5 : The time from valid data to B/L enable at power ON.
- T6 : The time from valid data off to B/L disable at power Off.

NOTE.

- (1) The supply voltage of the external system for the module input should be the same as the definition of VDD.
- (2) Apply the lamp voltage within the LCD operation range. When the back-light turns on before the LCD operation or the LCD turns off before the back-light turns off, the display may momentarily become white.
- (3) In case of VDD = off level, please keep the level of input signals on the low or keep a high impedance.
- (4) T4 should be measured after the module has been fully discharged between power off and on period.
- (5) Interface signal shall not be kept at high impedance when the power is on.

7. MECHANICAL OUTLINE DIMENSION

Product Information

[Refer to the next page]

Doc.No.	LTN154U2-L04	ISSUED DATE	2006-07-28	Page	12 / 13
----------------	--------------	--------------------	------------	-------------	---------

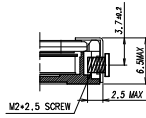

SECTION A-A'

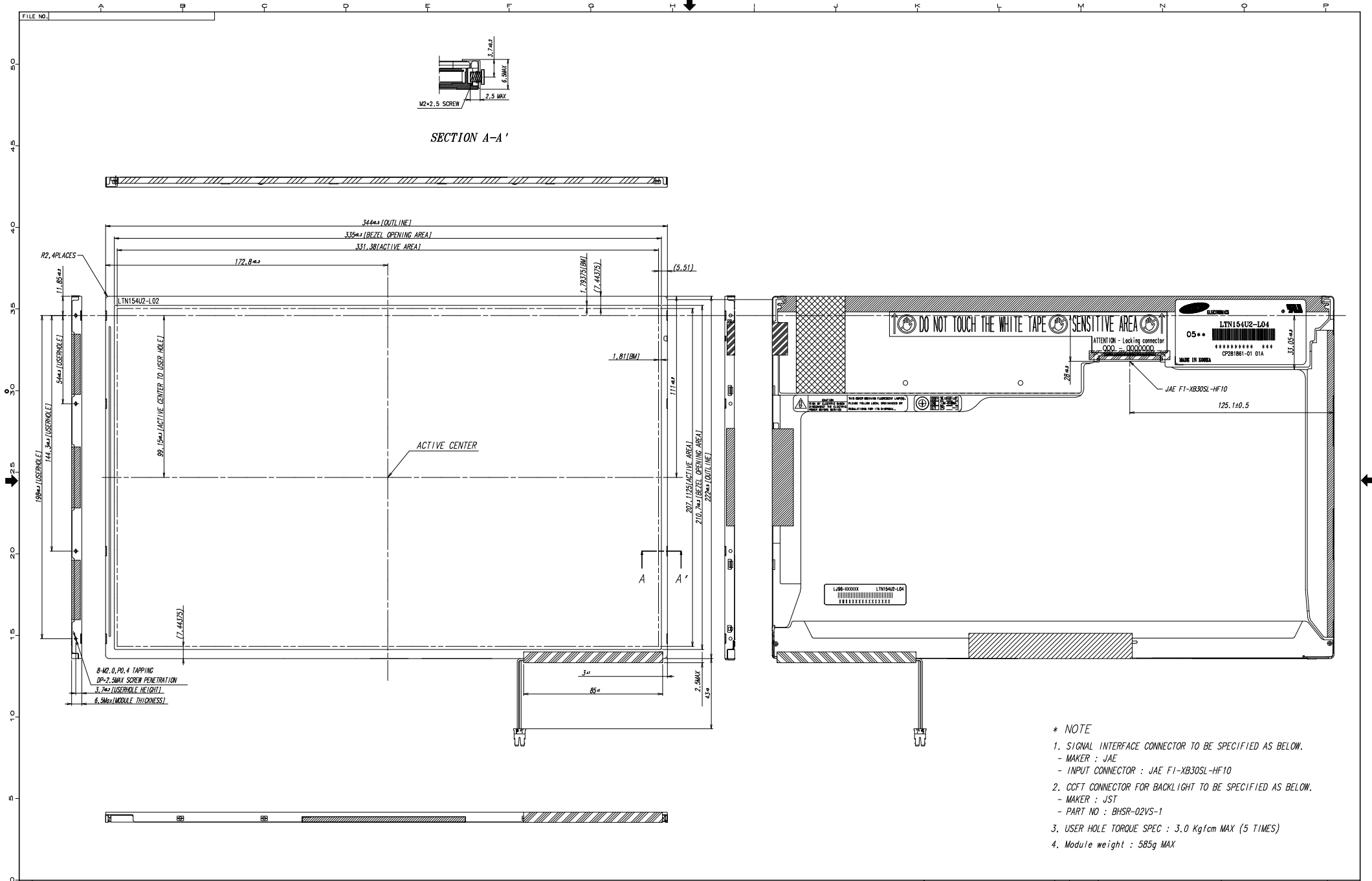

- * NOTE
- SIGNAL INTERFACE CONNECTOR TO BE SPECIFIED AS BELOW.
- MAKER : JAE
- INPUT CONNECTOR : JAE F1-XB30SL-HF10
 - CCFT CONNECTOR FOR BACKLIGHT TO BE SPECIFIED AS BELOW.
- MAKER : JST
- PART NO : BHSR-02VS-1
 - USER HOLE TORQUE SPEC : 3.0 Kg/cm MAX (5 TIMES)
 - Module weight : 583g MAX

GENERAL TOLERANCE				REV.	DATE	DESCRIPTION OF REVISION			REASON	CHK'D BY
STEP	LEVEL 1	LEVEL 2	LEVEL 3	UNIT	REV.	DRG.'N BY	DES'G BY	CHK'D BY	MODEL NAME	
0 < X ≤ 4	±0.05	±0.1	±0.2	SCALE	1:1		Y.K.KIM	N.S.KIM	D.C.YANG	LTN154U2-L04
4 < X ≤ 16	±0.08	±0.15	±0.3	TOLERANCE						PART/SHEET NAME
16 < X ≤ 64	±0.12	±0.25	±0.5	LEVEL 3			05.10.12	05.10.12		OUTLINE DIMENSION
64 < X ≤ 256	±0.25	±0.4	±0.8							SHEET 1/1
SAMSUNG ELECTRONICS										VER. 000